



LEVANTE

# Stainless Steel Air Curtain Supplier

[www.aircurtainsupplier.com.au](http://www.aircurtainsupplier.com.au)

Phone: +613.97948182

[info@aircurtainsupplier.com.au](mailto:info@aircurtainsupplier.com.au)

## STAINLESS STEEL AIR CURTAINS INSTALLATION MANUAL

**FM-4009S-L/Y**

**FM-4010S-L/Y**

**FM-4012S-L/Y**

**FM-4015S-L/Y**

**FM-4018S-L/Y**

**FM-4020S-L/Y**



**Thanks for purchasing this Air Curtain,  
Please read these instructions carefully before use.**

## 1、 IDENTIFICATION & INSTALLATION DIMENSIONS

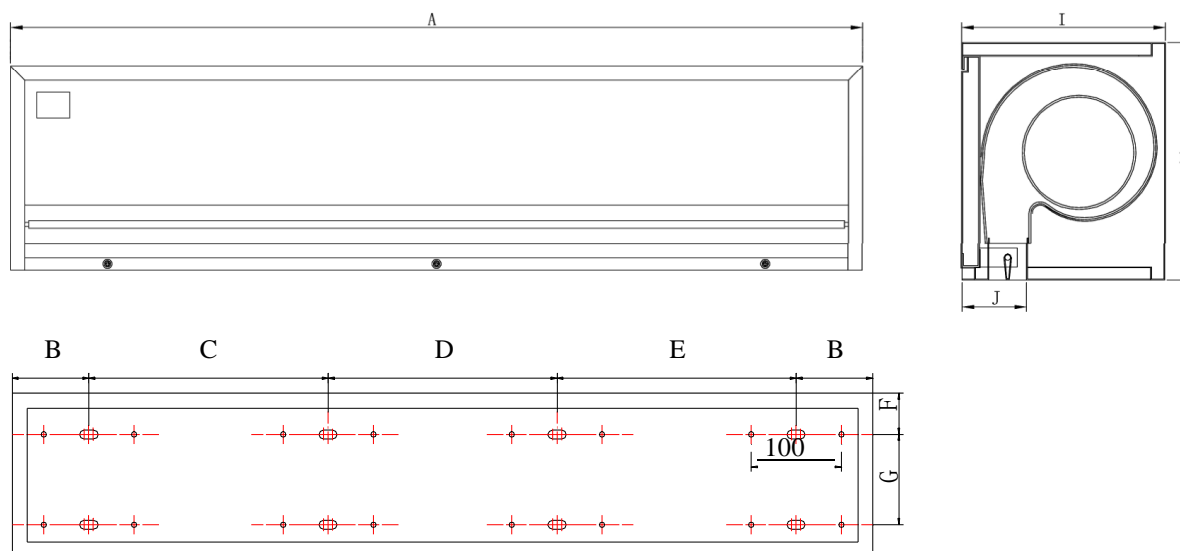

MODEL	A	B	C	D	E	F	G	H	I	J
FM-4009S-L/Y	900	95	347.5	---	347.5	64	100	240	215	70
FM-4010S-L/Y	1000	145	347.5	---	347.5					
FM-4012S-L/Y	1200	95	347.5	295	347.5					
FM-4015S-L/Y	1500		390.5	504	390.5					
FM-4018S-L/Y	1800		695	190	695					

## 2、 INSTALLATION CAUTION

Must follow the following when installing stainless steel air curtain:

<p>2.1 Please install the unit in a sturdy place to avoid shaking and ensure that it's secure.</p>	<p>2.2 Please install the unit inside the room.</p>
--	---

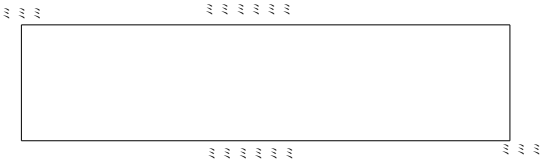
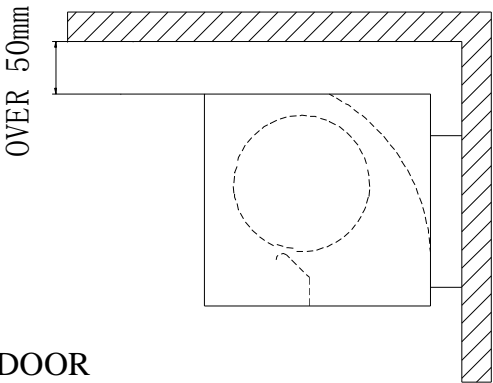
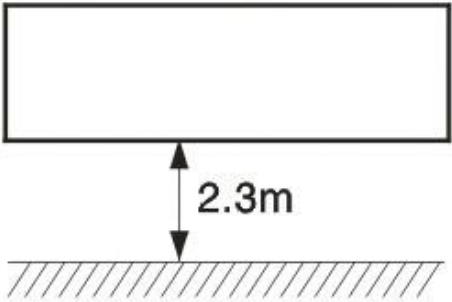
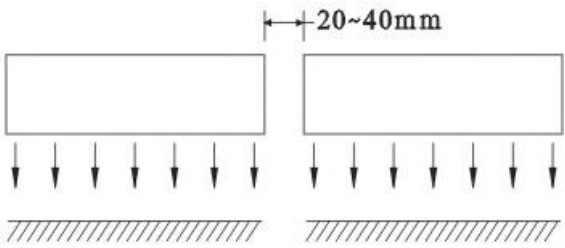
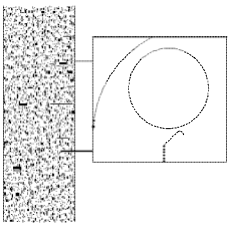
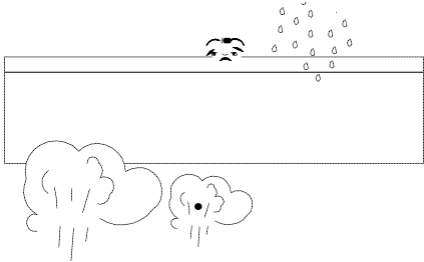

	 <p>OVER 50mm</p> <p>INDOOR</p> <p>OUTDOOR</p>
<p>2.3 Don't install the unit too low, no less than 2.3 meter from the ground.</p>  <p>2.3m</p>	<p>2.4 When the entrance is wider than the unit, it is recommended to install two or more units in parallel. In this case, provide 20-40mm gaps between the units.</p>  <p>20~40mm</p>
<p>2.5 Don't allow gaps between the unit and the wall.</p> 	<p>2.6 Don't install the unit in a place where it is splashed by water, exposed to excessive steam, explosive or corrosive gas.</p> 

### 3、INSTALLATION

#### A、Installing onto the concrete wall:

<p>3.1.1 Remove the mounting plate</p> <p>Unclamp the fixing screws on the back of main body to remove the mounting plate.</p>	<p>3.1.2 Fix the bolts in the proper position (Decide the position with the mounting plate and pour cement into the bolt holes.)</p>
--	--

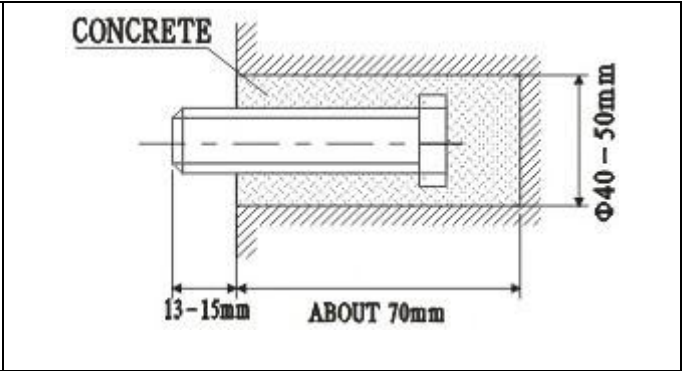
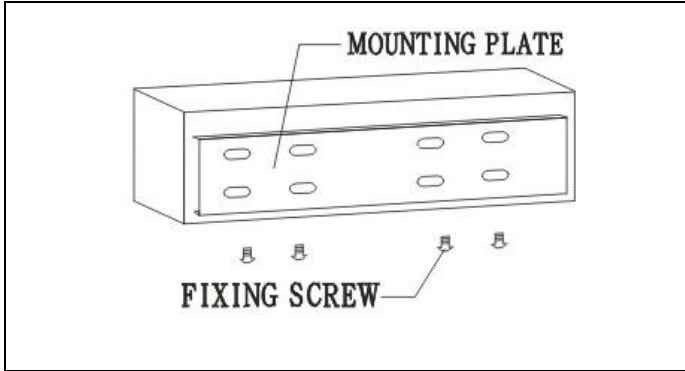

3.1.3 When the cement has set, fit the mounting plate (use the washer and nut according to the following)

3.1.4 Install the main body  
Set the main body onto the upper end of the mounting plate and clamp it as shown.

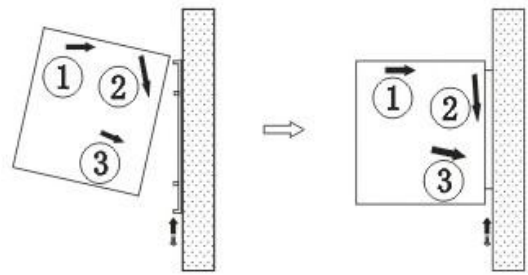
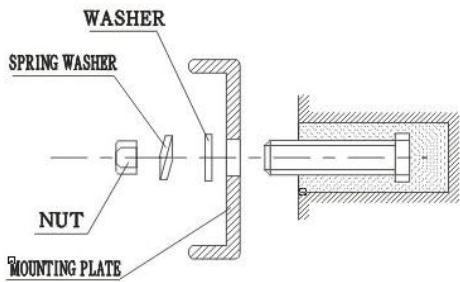

**B、 Installing to a wooden wall**

3.2.1 Fix the mounting plate in the proper position with tapping screws.

3.2.2 Same as step 3 of A

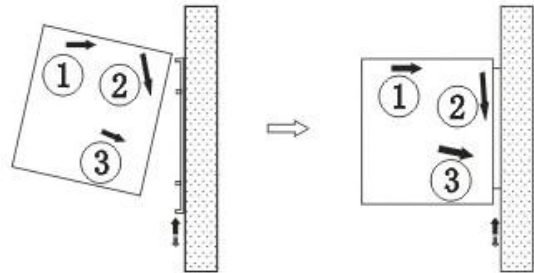
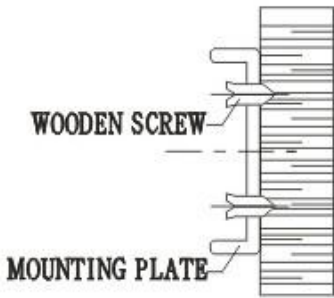

**C、 Hanging from the ceiling**

3.3.1 Remove the mounting plate from main body (Same as step 3.1.1)

3.3.2 Fix ceiling brackets as Fig.

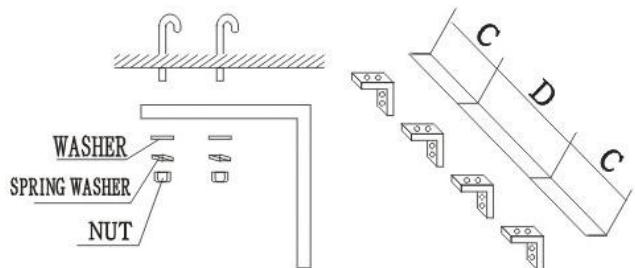
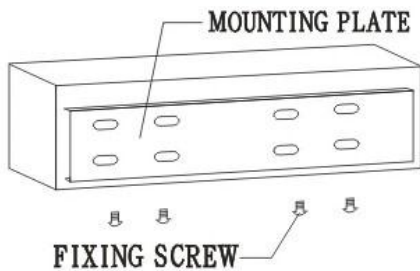

3.3.3 Set the mounting plate on the ceiling brackets and ensure safe & fixing (use the bolts attached to the ceiling brackets as Fig3.3.2). Using the ceiling brackets to hang from the ceiling, the position of mounting plate can be adjusted in the limit of 100mm.

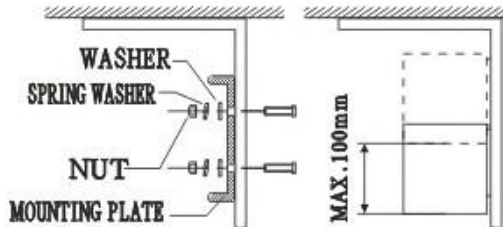

3.3.4 Do the same as step A to install the main body.

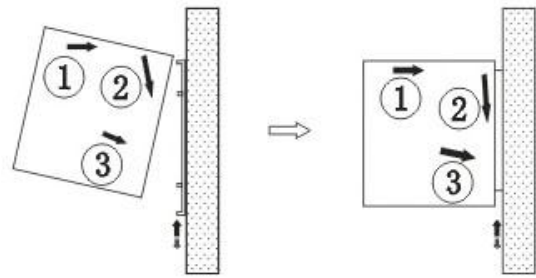

**D、 For above ceiling – recessed mounted**

3.4.1 Fix the air curtain as in the procedure for installing on the concrete wall.

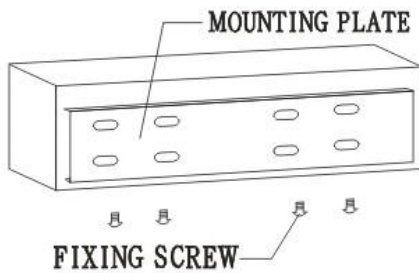

3.4.2 Then pipe as right Fig. Instructs.

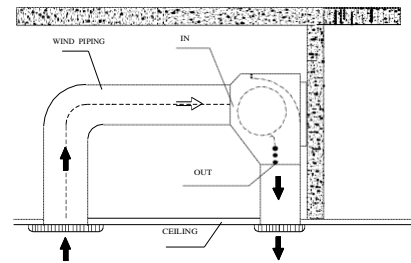

**4、 TECHNICAL PARAMETER**

Model	Air Volume m <sup>3</sup> /h		Air Volume l/s		Air Velocity m/s		Noise Level dBA @ 1 metre		Dimensions L x H x W	Supply V	Input power W		Net Weight
	High	Low	High	Low	High	Low	High	Low			High	Low	
FM-4009S-L	1400m <sup>3</sup> /h	1000m <sup>3</sup> /h	388	277	20m/s	16m/s	57	54	900x215x240	240V, 50Hz	300W	270W	14kg
FM-4012S-L	1900m <sup>3</sup> /h	1500m <sup>3</sup> /h	527	416	20m/s	16m/s	58	55	1200x215x240	240V, 50Hz	400W	370W	19kg
FM-4015S-L	2300m <sup>3</sup> /h	1900m <sup>3</sup> /h	638	527	20m/s	16m/s	61	58	1500x215x240	240V, 50Hz	500W	470W	25kg
FM-4018S-L	2850m <sup>3</sup> /h	2250m <sup>3</sup> /h	791	625	20m/s	16m/s	63	60	1800x215x240	240V, 50Hz	600W	570W	28kg
FM-4020S-L	3255m <sup>3</sup> /h	2855m <sup>3</sup> /h	904	793	20m/s	16m/s	64	62	2000x215x240	240V, 50Hz	620W	590W	30kg



## 5、 Wiring Diagram

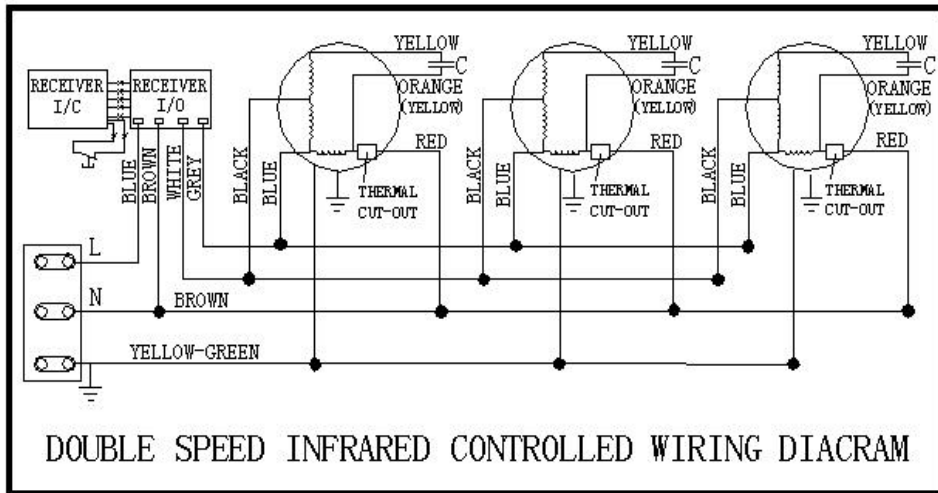

DOUBLE SPEED SWITCH WIRING DIACRAM

## 6、 OPERATION

- 6.1 Turn on the power switch
- 6.2 Select the best speed : High[H]、 Low[L]
- 6.3 According to using to adjust the grate to obtain the best effect.

## 7、 CAUTIONS

- a)、 Use the unit at the rate voltage and frequency indication on the name plate.
- b)、 Disconnect power source before unit operation. c)、 Routing maintenance must be done every year.
- d)、 Never use petrol, benzene, thinner or any other such chemical for clearing the unit. e)、 Don't allow water or anything enter the motor.
- f)、 When power supply comes from socket, the plug must accord with IEC335-1. When the power cord is connected with charging line directly, all polarity switches that the contact gap is 3mm at least must be installed in the charging line.

---

WARRANTY, ALL CURTAINS: 12 months parts only.

Distributed by:

CLEAN AIR SERVICES PTY. LTD.

1/147 GREENS ROAD DANDENONG SOUTH VICTORIA AUSTRALIA 3175

TEL: 03.97948182 FAX: 03.97935707

EMAIL: [info@cleanairservices.com.au](mailto:info@cleanairservices.com.au)